

Biscuit  
Machines

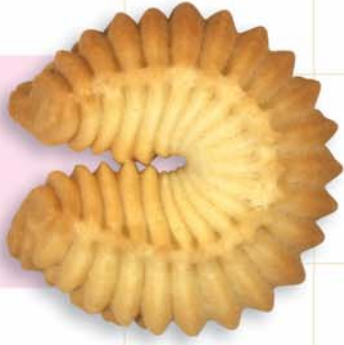

**MIMAC**

food processing equipment

# Baby Drop



**italiano** Progettata per essere la più piccola e versatile colatrice per la produzione di pasticceria e biscotteria, la nuova BABYDROP della MIMAC si propone per soddisfare i più raffinati ed esigenti laboratori di pasticceria che abitualmente lavorano con teglie formato 400 x 600 mm. L'affidabilità della tecnologia di MIMAC ITALIA S.r.l. ed il design curato e razionale si combinano in un progetto costruttivo che permette di incontrare le esigenze dei potenziali Clienti. Una vastissima gamma di bocchette e stampi consentono la realizzazione di prodotti in svariate forme e dimensioni lasciando ampia creatività all'utilizzatore. Lasciate spazio alla fantasia, al resto ci pensa MIMAC.

**english** Designed to be the smallest and most versatile dropping machine for pastry-, biscuit- and cookie-making, the new BABYDROP from MIMAC is designed to satisfy the needs of the most refined, exacting pastry makers who usually use 400 x 600 mm trays. MIMAC ITALIA S.r.l. has combined reliable technology with well thought out, rational design to build a product that will satisfy the needs of potential customers. A vast range of nozzles and moulds make it possible to create products in a variety of shapes and sizes leaving ample space for creativity on the part of the user. Make room for your imagination, MIMAC will do the rest.

**français** De conception extrêmement compacte et universelle, la nouvelle dresseuse pour la production de gâteaux et de biscuits BABYDROP de MIMAC répondra aux nécessités des pâtisseries les plus raffinés et exigeants utilisant généralement des plaques format 400 x 600 mm. La fiabilité de la technologie MIMAC ITALIA S.r.l. et un design attentif et rationnel s'associent dans un projet permettant de répondre aux exigences de la clientèle. Une très ample gamme de douilles et de moules permettent à l'utilisateur de réaliser différentes formes et dimensions de produit en laissant libre cours à son imagination. Laissez parler votre imagination, MIMAC pense au reste.

**deutsch** Als kleinste und vielseitigste Dressiermaschine für die Herstellung von Konditoreiwaren und Gebäck konstruiert, wendet sich die neue BABYDROP von MIMAC vor allem an die raffiniertesten und anspruchsvollsten Konditoreistuben, die üblicherweise mit Backblechen des Formats 400 x 600 mm arbeiten. Die zuverlässige Technik von MIMAC ITALIA S.r.l. und das rationelle, durchdachte Design verbinden sich zu einem Projekt, das potentielle Kunden anspricht. Eine riesige Auswahl an Austrittsdüsen und Formen läßt der Kreativität des Betreibers viel Spielraum und ermöglicht Produkte unterschiedlichster Formen und Maße. Lassen Sie Ihrer Phantasie freien Lauf, für den Rest sorgt MIMAC.

**español** Diseñada para ser la más pequeña y versátil dosificadora para la producción de pastelería y galletería, la nueva BABYDROP de MIMAC se propone para satisfacer los laboratorios de repostería más refinados y exigentes que normalmente trabajan con bandejas formato 400 x 600 mm. La fiabilidad de la tecnología de MIMAC ITALIA S.r.l. y el diseño cuidado y racional se combinan en un proyecto de construcción que permite responder a las exigencias de los potenciales Clientes. Una amplísima gama de bocas y de moldes permiten la realización de productos en un sinnúmero de formas y dimensiones, dejando una amplia creatividad al usuario. Den espacio a la fantasía; del resto se ocupará MIMAC.

## Gruppi di dosaggio

Dosing units - Groupes de dosage - Dosiergruppen - Grupos de dosificación

### Testata a Pompa

Pump head  
Tête à pompe  
Pumpenkopf  
Cabezal de bomba

### Testata a Rulli

Rollers head  
Tête à rouleaux  
Rollenkopf  
Cabezal de rodillos

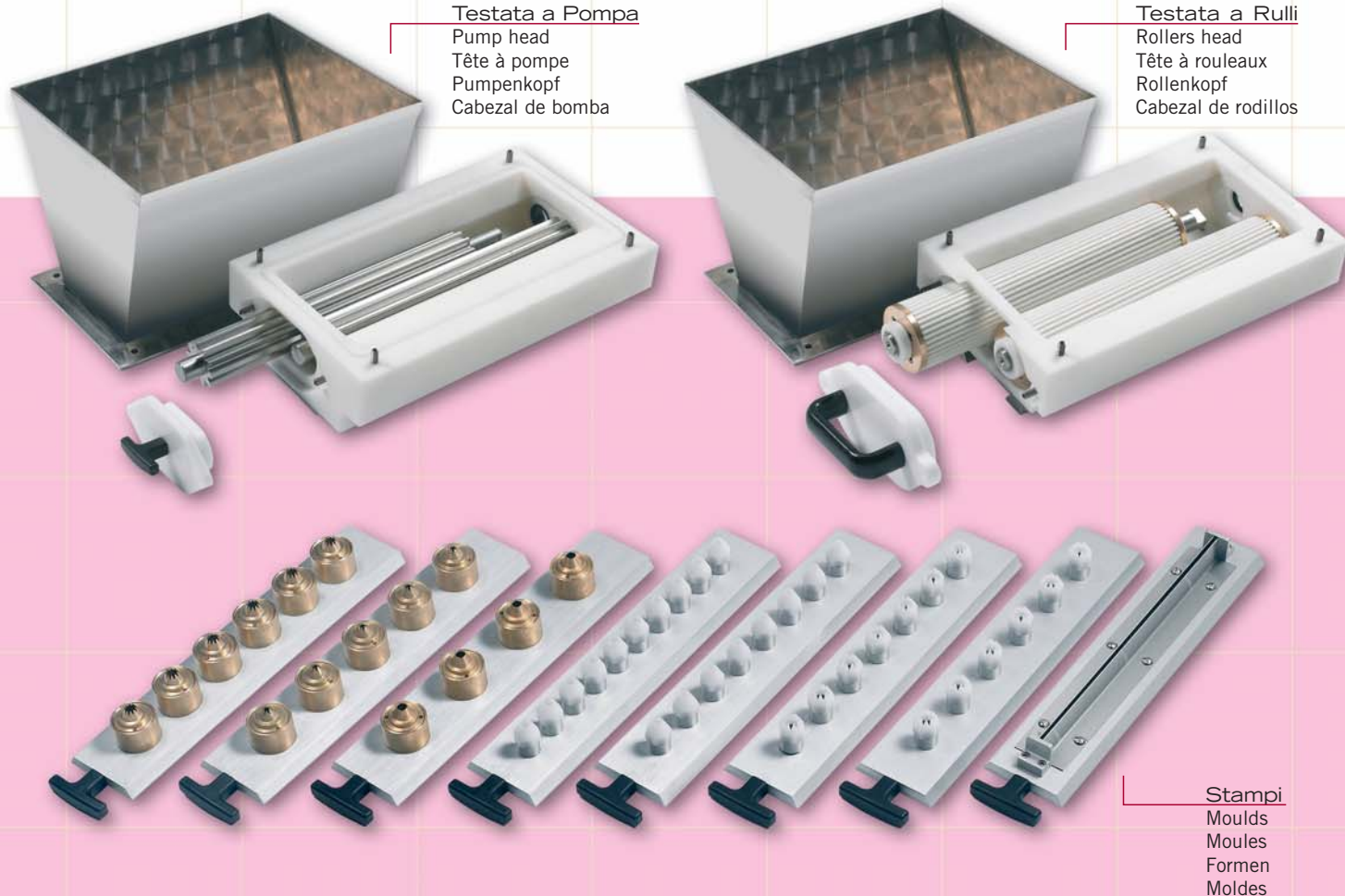

Stampi  
Moulds  
Moules  
Formen  
Moldes

# Stampo Fisso



Stationary mould - Moule fixe - Fester Form - Molde fijo

1



2



3



4



5



6



7



8



9



10



11



12



13



14



15



16

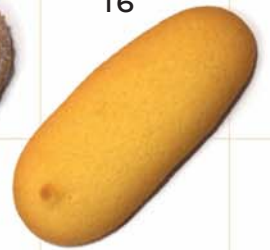

17



18



19



20



21

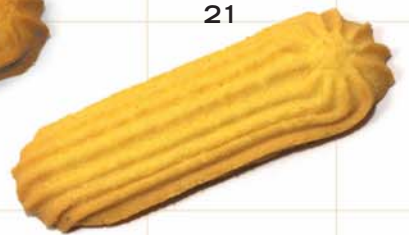

22



23



24



25

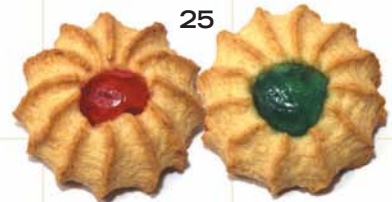

26



27



28



29

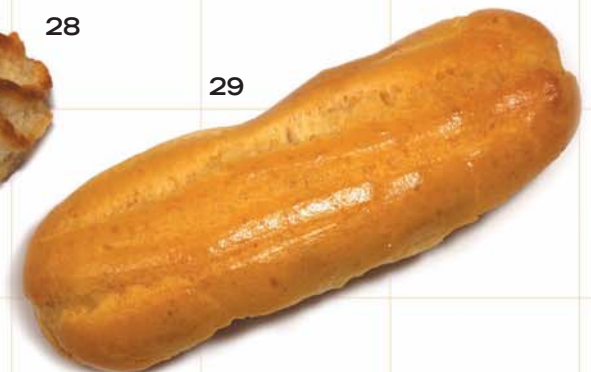

# Stampo Fisso

Stationary mould - Moule fixe - Fester Form - Molde fijo



F1



F2



F3



F4



F5



F6



F7



F8



F9



F10



F11



F12



F13



F14



F15



F16





F17



F18



F19



F20



F21



F22



F23



F24



F25



F26



F27



F28



F29



F30



F31



F32



# Testata a Pompa

Pump head - Tête à pompe - Pumpenkopft - Cabezal de bomba

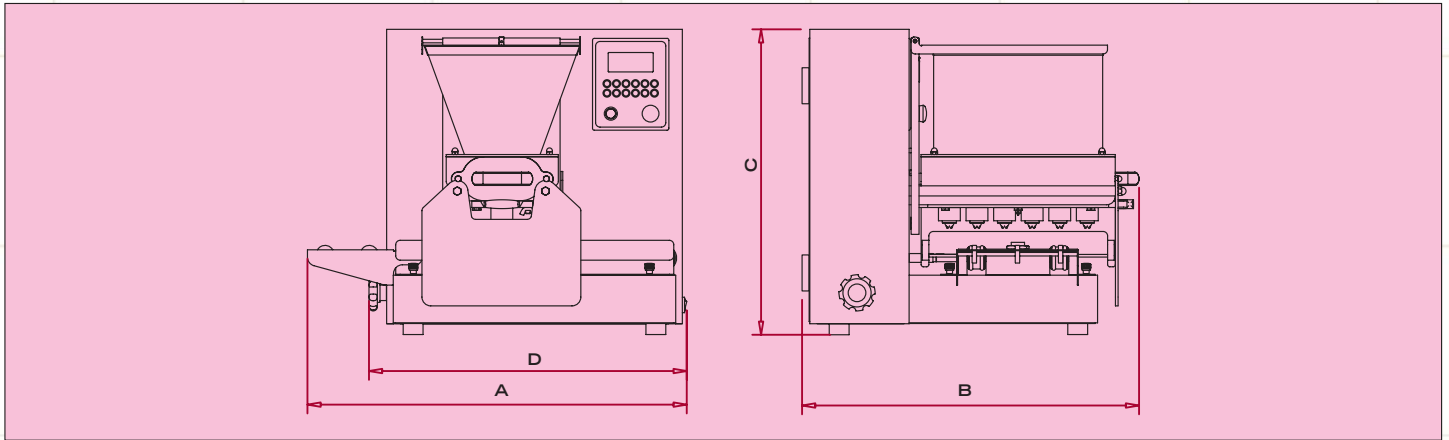

DATI TECNICI TECHNICAL DATA DONNEES TECHNIQUES TECHNISCHE DATEN DATOS TÉCNICOS	Teglie Trays Plaques Blechen Bandejas (mm)	Dimensioni - Dimensions - Dimensions - Außenmaße - Dimensiones				Peso Weight Poids Gewicht Peso (kg)	Potenza Power Puissance Stärke Potencia (kW)
		A (mm)	B (mm)	C (mm)	D (mm)		
BABYDROP 400	400X600	860	764	690	720	150	1
BABYDROP 450	450X650	860	804	690	720	150	1

MIMAC ITALIA S.R.L. si riserva di apportare eventuali modifiche tecniche e costruttive. - MIMAC ITALIA S.R.L. reserves the right to make any technical and structural modification.  
MIMAC ITALIA S.R.L. se réserve le droit d'apporter éventuelles modifications techniques et de construction. - MIMAC ITALIA S.R.L. behält sich vor technische und bauliche Änderungen vorzunehmen.  
MIMAC ITALIA S.R.L. se reserva la facultad de aportar eventuales modificaciones técnicas y constructivas.

*Decorazioni, guarniture ed accoppiamenti sono fatti a mano. Savoïardi, madeleines e plum-cakes sono colati in teglie opportunamente stampate.*

*Topping, dressing and stacking are made by hand. Lady-fingers, madeleines and plum-cakes are dropped on suitable moulded trays.*

*Décorations, garnitures ed combinazioni sono fatte à la main. Biscuits à la cuiller, madeleines et plum-cakes sont dosés en plaques préformées.*

*Die Verzierungen und die Verbindungen von zwei Produkten werden handgefertigt. Löffelbiskuite, Madeleines und Sandkuchen werden auf passende vorgebildete Kuchenformen gespritzt.*

*Decoraciones, guarniciones y uniones de productos son hechas a mano. Galletas de Savoïa, magdalenas y plum-cake son dosificados en bandejas moldeadas.*

**MIMAC**  
food processing equipment

MIMAC ITALIA s.r.l.  
Via dell'Industria, 22  
36013 PIOVENE ROCCHETTE (VI)  
Tel. 0445.576250 - Fax 0445.576112  
info@mimac.com

Agency: