

# EURO

Forno elettrico modulare per pizzeria, pasticceria e panetteria

Modular electric oven for pizza, pastry and bread



## EURO STAND - ES12 I/R

### CARATTERISTICHE TECNICHE

- 1 - 2 - 3 camere di cottura interamente in acciaio alluminato con piano cottura in refrattario
- Piano di cottura e cielo con resistenze corazzate in acciaio inox
- Pannello di controllo elettromeccanico (opzione digitale su richiesta)
- Controllo delle temperature del piano di cottura e del cielo separate
- Isolamento termico
- Massima temperatura di cottura 450 °C
- Valvola regolabile per scarico vapori
- Sportello con finestra in vetro temperato
- Sportelli frontali controbilanciati
- Lampade alogene ad alta resistenza e capacità luminosa

### ACCESSORI

- Disponibile in acciaio inox o in stile rustico (I/R)
- Cella di lievitazione ermetica
- Supporto del forno
- Modulo cappa

### OPTIONAL

- Pannello di controllo digitale
- Vaporiera (assorbimento massimo 1,4 Kw)
- Kit abbattimento vapori e odori con filtro ai carboni attivi (assorbimento massimo 0,7 Kw)
- 4 ruote (h = 16 cm + 2 cm per la cella di lievitazione)
- Piedi per celle di lievitazione (h min = 8 cm / max = 20 cm)

### TECHNICAL SPECIFICATIONS

- 1 - 2 - 3 cooking chambers in aluminium coated steel plate with refractory cooking floor
- Top and bottom stainless steel armored heating elements
- Electromechanical control panel (digital optional by request)
- Top and bottom separate temperature control
- Thermal insulation
- Max cook temp 450 °C
- Adjustable steam exhaust valve
- Single tempered glazed door
- Counter balanced door
- High resistance and efficiency halogen lamps

### ACCESSORIES

- Available in stainless steel or rustic style (I/R)
- Hermetic prover
- Oven support
- Hood module

### OPTIONALS

- Digital control panel
- Steam injection system (max. absorption 1,4 Kw)
- Steam and odours damper kit for hood with active carbon filter (max. absorption 0,7 Kw)
- 4 wheels (h = 16 cm + 2 cm for the prover)
- Feet for provers (h min = 8 cm / max = 20 cm)

### VERSIONI

- Resistenze corazzate in acciaio inossidabile integrate nel refrattario del piano di cottura e del cielo
- Disponibile in versione **EURO "CLASSIC" - EC12 I/R** con 1 - 2 - 3 camere di cottura in materiale refrattario con piano cottura e cielo ad alte prestazioni e resistenza

### VERSIONS

- Stainless steel armored heating elements integrated in the refractory floor and ceiling
- Available in **EURO "CLASSIC" - EC12 I/R** version with 1 - 2 - 3 cooking chambers in full refractory material with high resisting and performing baking floor and ceiling

**ITALFORNI È UN BRAND DI WAICO GROUP**

ITALFORNI - Sede operativa  
Via dell'Industria, 130 - Loc. Chiusa di Ginestreto  
61122 Pesaro (PU) Italia - Tel. +39 0721 481515  
italforni@waicogroup.com - www.italforni.it

WAICO srl - Sede legale  
Via Scotte, 1 - Isola Vicentina  
36033 Vicenza (VI) Italia - Tel. +39 0445 1716598  
info@waicogroup.com - www.waicogroup.com

**1 CAMERA + SUPPORTO ALTO**  
1 DECK + HIGH STAND

ALLACCIO ELETTRICO  
ELECTRIC CONNECTION

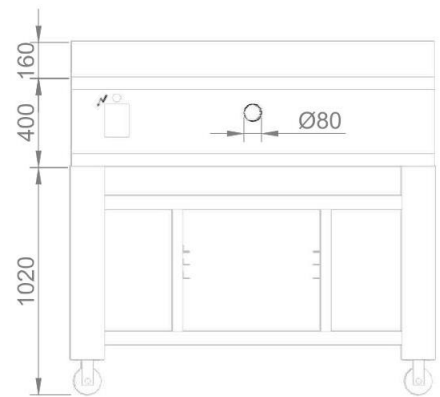
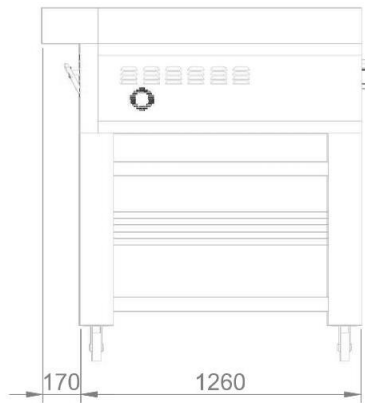
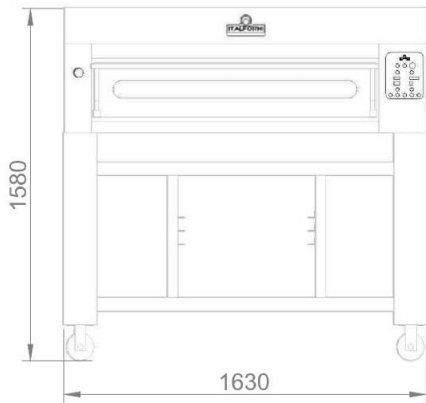

**1 CAMERA + CELLA DI LIEVITAZIONE ALTA**  
1 DECK + HIGH PROVER

ALLACCIO ELETTRICO  
ELECTRIC CONNECTION

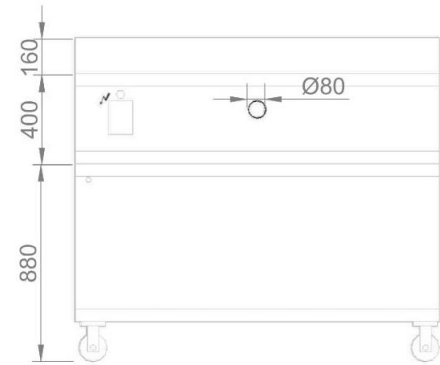
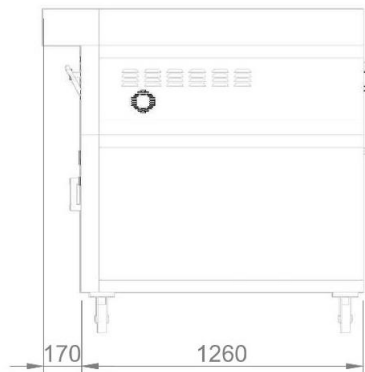
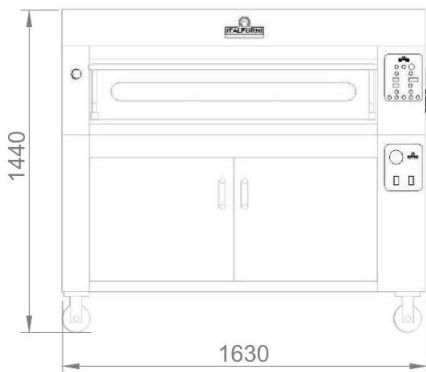

**2 CAMERE + SUPPORTO ALTO**  
2 DECKS + HIGH STAND

ALLACCIO ELETTRICO  
ELECTRIC CONNECTION

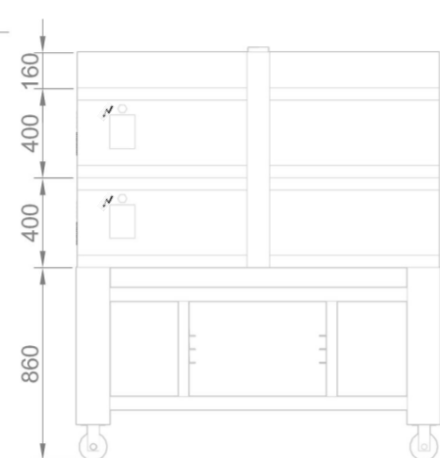
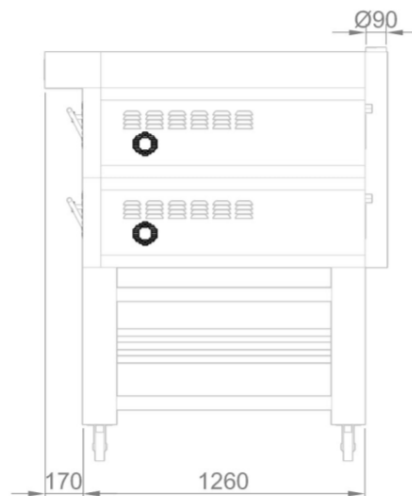
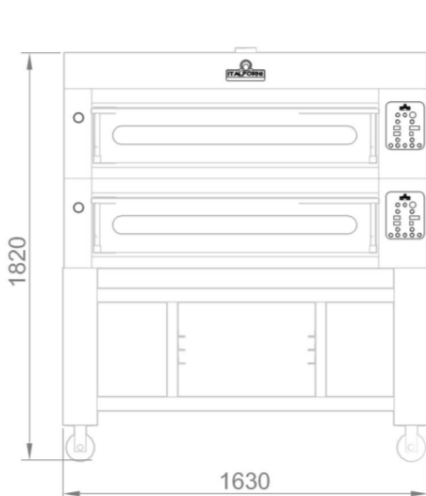

ITALFORNI È UN BRAND  
DI WAICO GROUP

ITALFORNI - Sede operativa  
Via dell'Industria, 130 - Loc. Chiusa di Ginestreto  
61122 Pesaro (PU) Italia - Tel. +39 0721 481515  
italforni@waicogroup.com - www.italforni.it

WAICO srl - Sede legale  
Via Scotte, 1 - Isola Vicentina  
36033 Vicenza (VI) Italia - Tel. +39 0445 1716598  
info@waicogroup.com - www.waicogroup.com

**2 CAMERE + CELLA DI LIEVITAZIONE ALTA**  
**2 DECKS + HIGH PROVER**

ALLACCIO ELETTRICO  
 ELECTRIC CONNECTION

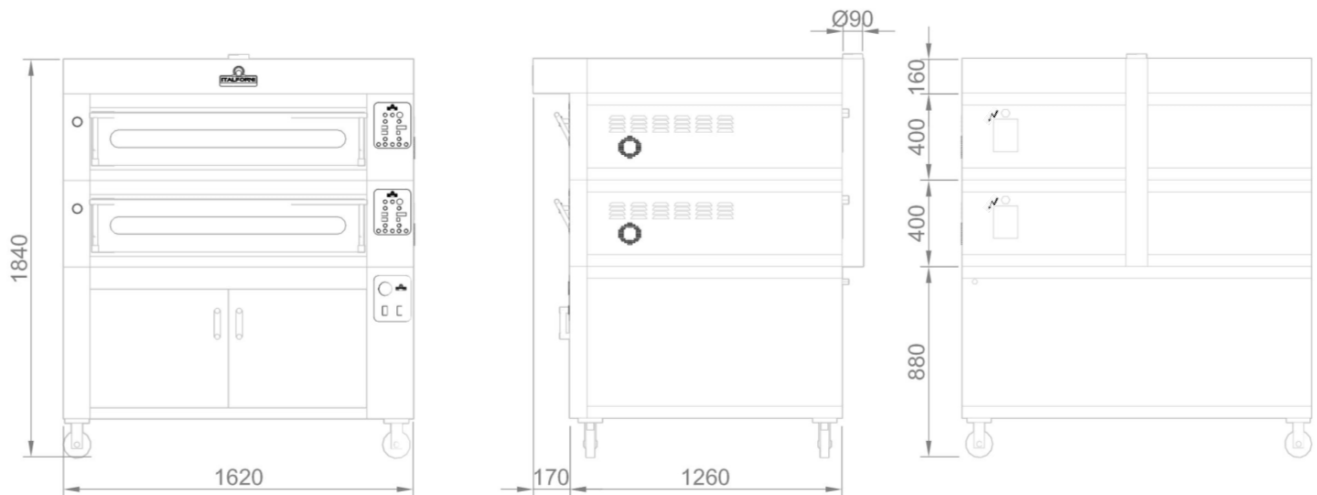

**3 CAMERE + SUPPORTO BASSO**  
**3 DECKS + LOW STAND**

ALLACCIO ELETTRICO  
 ELECTRIC CONNECTION

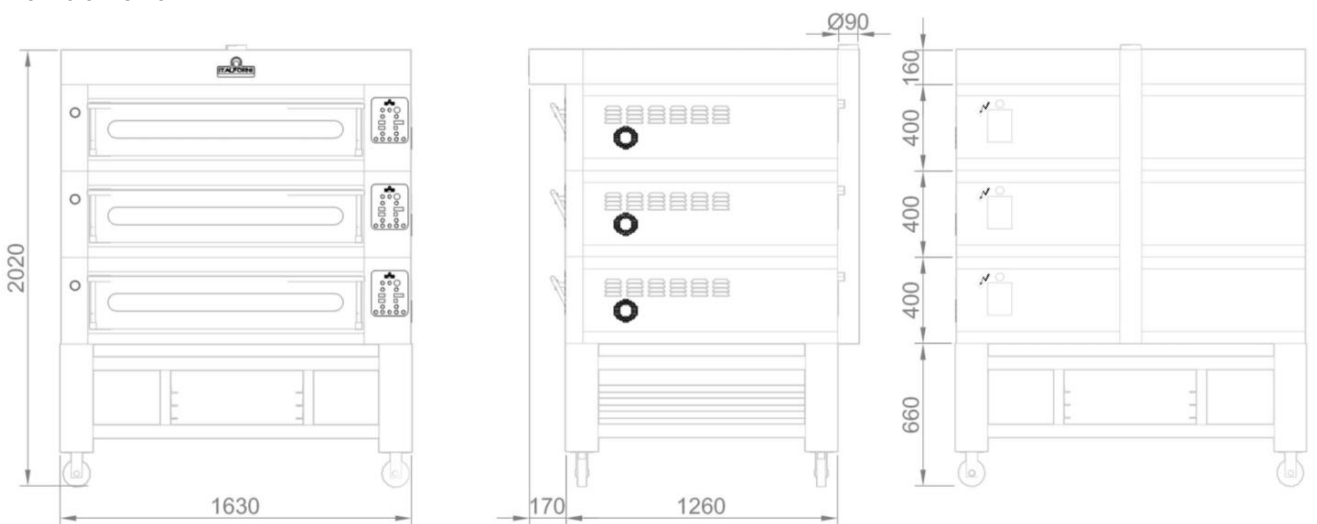

**3 CAMERE + CELLA DI LIEVITAZIONE BASSA**  
**3 DECKS + LOW PROVER**

ALLACCIO ELETTRICO  
 ELECTRIC CONNECTION

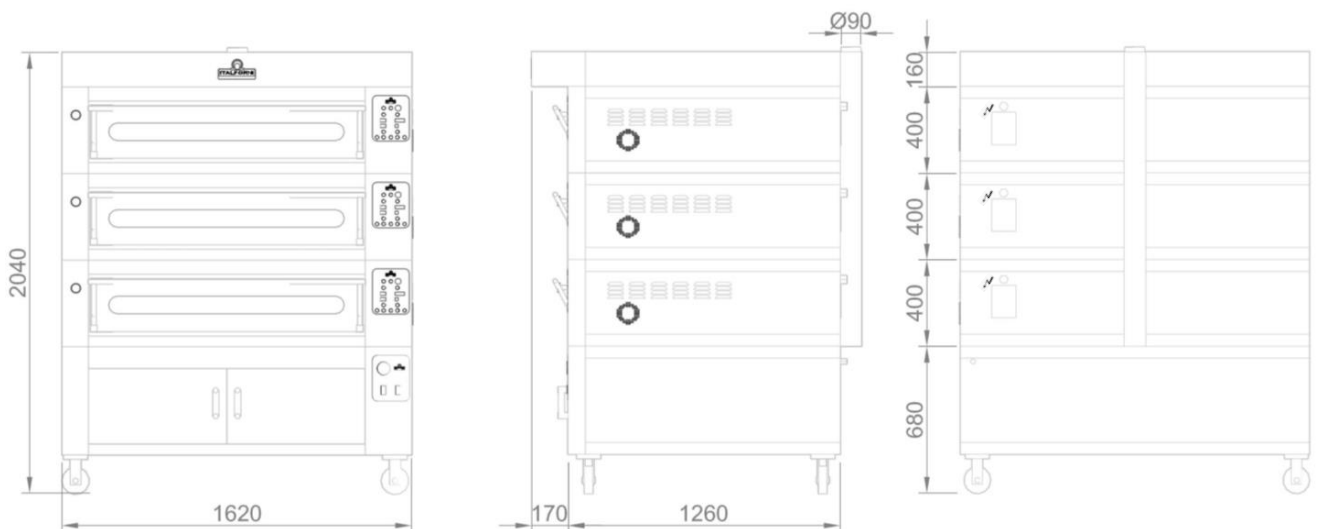

**ITALFORNI È UN BRAND  
 DI WAICO GROUP**

ITALFORNI - Sede operativa  
 Via dell'Industria, 130 - Loc. Chiusa di Ginestreto  
 61122 Pesaro (PU) Italia - Tel. +39 0721 481515  
 italforni@waicogroup.com - www.italforni.it

WAICO srl - Sede legale  
 Via Scotte, 1 - Isola Vicentina  
 36033 Vicenza (VI) Italia - Tel. +39 0445 1716598  
 info@waicogroup.com - www.waicogroup.com

**VALVOLA REGOLABILE PER SCARICO VAPORI**  
ADJUSTABLE STEAM EXHAUST VALVE

Vista dall'alto 1 camera  
Top view 1 deck

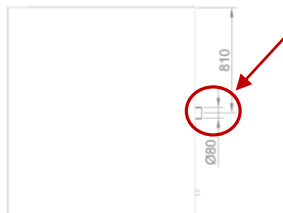

Vista dall'alto 2 o 3 camere  
Top view 2 or 3 decks

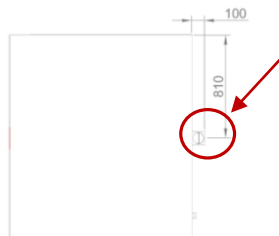

**VAPORIERA**  
STEAM INJECTION SYSTEM

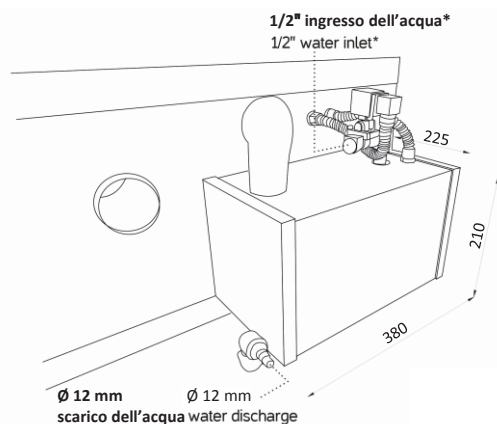

\*Deve essere installato un riduttore di pressione massima di 0.5/0.6 bar  
\*0.5/0.6 bar max pressure reduce has to be installed  
Assorbimento massimo 1,4 Kw  
Max. absorption 1,4 Kw

**CAPACITÀ DI CARICO PER CAMERA**  
LOADING CAPACITY PER DECK

EC12 I/R DIMENSIONI INTERNE  
ES12 I/R Internal dimensions  
A/H 17 x L/W 123 x P/D 93 cm  
12 Pizze Ø 30 cm  
4 Teglie 60x40 cm  
4 Baking pans 60x40 cm

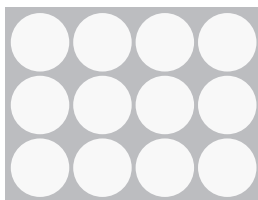

**DATI TECNICI**  
TECHNICAL CHART



Euro	Dimensioni interne (cm)			Dimensioni esterne (cm)			Peso	Alimentazione	Potenza	Potenza	Assorbimento	Temperatura	N° Teglie
	Internal dimensions (cm)			External dimensions (cm)			Weight	Supply	Power	Power	Absorption	Temperature	# Baking pans
	A/H	L/W	P/D	A/H	L/W	P/D	KG	V/Ph/Hz	KW	KW/h	Ampere	°C	60x40 cm
EC12 / ES12 I/R - DECK	17	123	93	40	162	126	260/220	400/3/50-60	12,5	6	20	0/450	
KC12 / KS12 - HOOD				16	162	143	45						
BC12 / BS12 - PROVER				70/50	162	126	120/105	230/1/50-60	1	0,5		0/90	28/12
SEC12 / SES12 - STAND				86/70/50	163	126	56/51/44						24/9/9

I = Frontale Acciaio Inox / Stainless Steel Front

R = Frontale rustico / Country Style Front

ITALFORNI È UN BRAND  
DI WAICO GROUP

ITALFORNI - Sede operativa  
Via dell'Industria, 130 - Loc. Chiusa di Ginestreto  
61122 Pesaro (PU) Italia - Tel. +39 0721 481515  
italforni@waicogroup.com - www.italforni.it

WAICO srl - Sede legale  
Via Scotte, 1 - Isola Vicentina  
36033 Vicenza (VI) Italia - Tel. +39 0445 1716598  
info@waicogroup.com - www.waicogroup.com

CE I dati riportati sul presente documento sono da ritenersi non vincolanti. Waico srl si riserva di apportare modifiche tecniche in qualsiasi momento.  
The specifics shown in this document are to be considered not binding. Waico srl reserves the right to make technical changes at any moment.